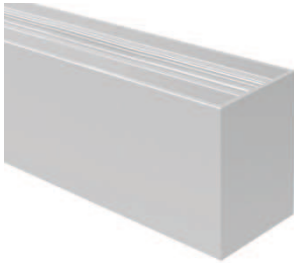
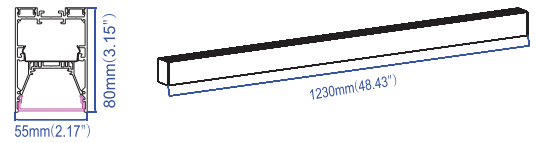

ColorView® Linear Up Down Light Fixture
TLI5580D-A44(S/W/B)(2835K/3000K/4000K/6500K)

Features

- Aluminum 6063, good heat radiation with long lifespan;
- Support 0-1 0V, PWM and Resistor dimming solution;
- High lighting efficiency, save energy;
- Long Life Span ≥ 50000 hours;
- Light source adopts LM-80 certified LED;
- Adopt UL Class P certified power supply;
- No Blue Spike, No Blue Hazard, Ultra High CRI

Parameter

Size	1230mm(4.04ft)X55mm(0.18ft)X80mm(0.26ft)
Beam angle	96°(PDM)
Working voltage	100~277VAC /50~60Hz
PF	≥ 0.9
Input power	total : 44W(11W/ft) up : 18W(4.5W/ft) down : 27W(6.7W/ft)
CCT	2835K, 3000K, 4000K, 6500K
CRI	97+
Lumen	total : 4200~4455lm(1050~1113lm/ft) up : 1680~1780lm(420~445lm/ft) down : 2520~2675lm(630~668lm/ft)
Energy efficiency	A
Dimming range	1~100%
Operating temperature	-20°C~+45°C
Storage temperature	-40°C~+60°C
Humidity	40~75% RH
IP grade	IP40
Installation way	Pendant, wall mounted
Package size	1280mm(4.20ft)X115mm(0.38ft)X92mm(0.3ft)
Gross Weight	3.99Kg

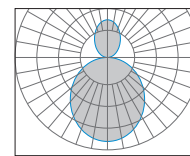
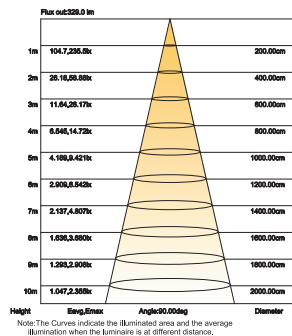
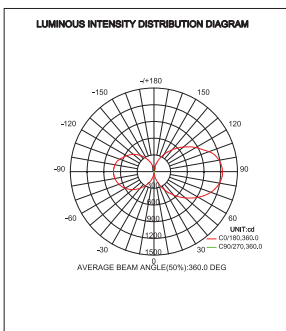
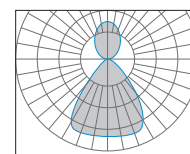
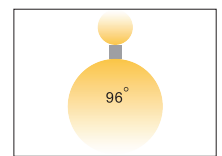
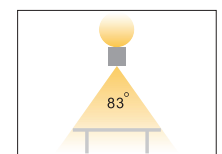
Size

Standard color

Test report

PDM

UGR < 19

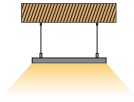
Remark:

- Output data is from test result of 4ft PDM linear light fixture;
- Tolerance $\pm 10\%$;

Optional accessories

Installation accessories



• Pendant



L-PTB-S



L-PT-S



L-PTB-NPF-S



L-PTB-PF-S



• Wall mounted



L5580D-WM

L-PTB-S: pendant wires with canopy

L-PT-S :pendant wires without canopy

L-PTB-NPF-S: pendant wire + canopy without cable hole

L-PTB-PF-S: pendant wire + canopy with cable hole

L5580D-WM: wall mounted clip

Disassembly tool

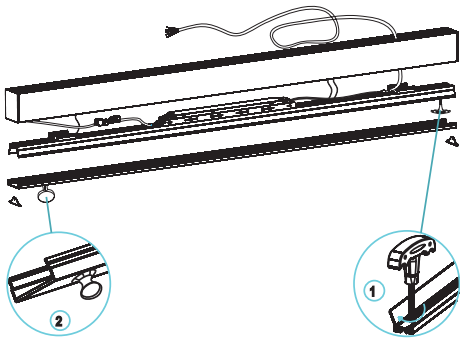

L-DA-D

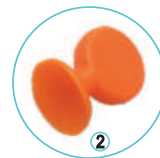

L-DA-A

• Tool

L-DA-D: disassembly tool

L-DA-A: Rubber sucker